

OWNER GUIDE

Classic1

INSET LIVE FUEL EFFECT GAS FIRE

(GC No. 32-032-55)

INCORPORATING THE

FireSlide CONTROL

(Manufacturer ref. 740FS)



**THIS APPLIANCE IS FOR USE WITH NATURAL GAS (G20)
WHEN CONVERTED USING CONVERSION KIT NO. 0595211 THIS
APPLIANCE IS FOR USE WITH PROPANE GAS (G31)
THIS APPLIANCE IS SUITABLE ONLY FOR INSTALLATION IN THE UNITED
KINGDOM (GB) AND THE REPUBLIC OF IRELAND (IE).**

This guide is intended to help you care for your gas fire. Please read thoroughly before using and keep for future reference

Manufactured exclusively for British Gas & Scottish Gas by Valor Heating,
Wood Lane, Erdington, Birmingham B24 9QP

For Service Phone 0845 950 0400

This guide to be left with the owner

OWNER GUIDE

LIST OF CONTENTS

Safety First.

This gas fire is CE Approved and designed to meet the appropriate British Standards and Safety Marks.



Quality and Excellence.

This fire has been manufactured to the highest standards of quality and excellence and was manufactured under a BS EN ISO 9001 quality system accepted by the British Standards Institute.



The Highest Standards

The manufacturer is a member of the Society of British Gas Industries which works to ensure high standards of safety, quality and performance.



Careful Installation

The manufacturer is a CORGI registered company. This gas fire must be installed by a competent CORGI Registered Installer in accordance with our Installer Guide and should not be fitted directly on to a carpet.

Valor Heating, Erdington, Birmingham B24 9QP

www.valor.co.uk

Because our policy is one of constant development and improvement, details may vary slightly from those given in this publication

OWNER GUIDE

<u>Section</u>	<u>Page</u>
SAFETY	4
APPLIANCE DIMENSIONS	6
OPERATING YOUR FIRE	7
The Oxysafe flame sensing & flue blockage safety system.	7
To light the fire	8
To turn the fire off	9
Lighting with a taper	9
CLEANING	10
Ceramic burner	10
Coals and burner compartment walls	10
Metal Parts	10
FUEL BED REFITTING	11
MAINTENANCE	16
Battery replacement	16
Regular maintenance	16
Servicing	16

This gas fire is designed to meet the most stringent quality, performance and safety requirements to provide you with many years' trouble-free service.

This guide aims to improve your understanding and appreciation of your gas fire by providing simple and informative instructions to ensure that you benefit from the excellent performance and features it has to offer.

OWNER GUIDE

SAFETY

IF YOU SMELL GAS

DON'T SMOKE

EXTINGUISH ALL NAKED FLAMES

DON'T TURN ELECTRICAL SWITCHES ON OR OFF

TURN OFF THE GAS SUPPLY AT THE METER

OPEN DOORS AND WINDOWS TO GET RID OF THE GAS

IMMEDIATELY CALL THE GAS EMERGENCY SERVICE - SEE YOUR LOCAL TELEPHONE DIRECTORY

Do have the fire installed by a competent person. In the United Kingdom, installation must be in accordance with the latest edition of the Gas Safety (installation & use) Regulations. In the Republic of Ireland, installation must be in accordance with all national and local regulations in force.

Do have the chimney swept prior to installation if it was previously used for solid fuel.

Do have the fire installed in accordance with the installation instructions.

Do provide a minimum clearance as shown in graph 1 above the hearth to any shelf made of wood or other combustible material. Please bear this in mind if you are making any alterations to the room.

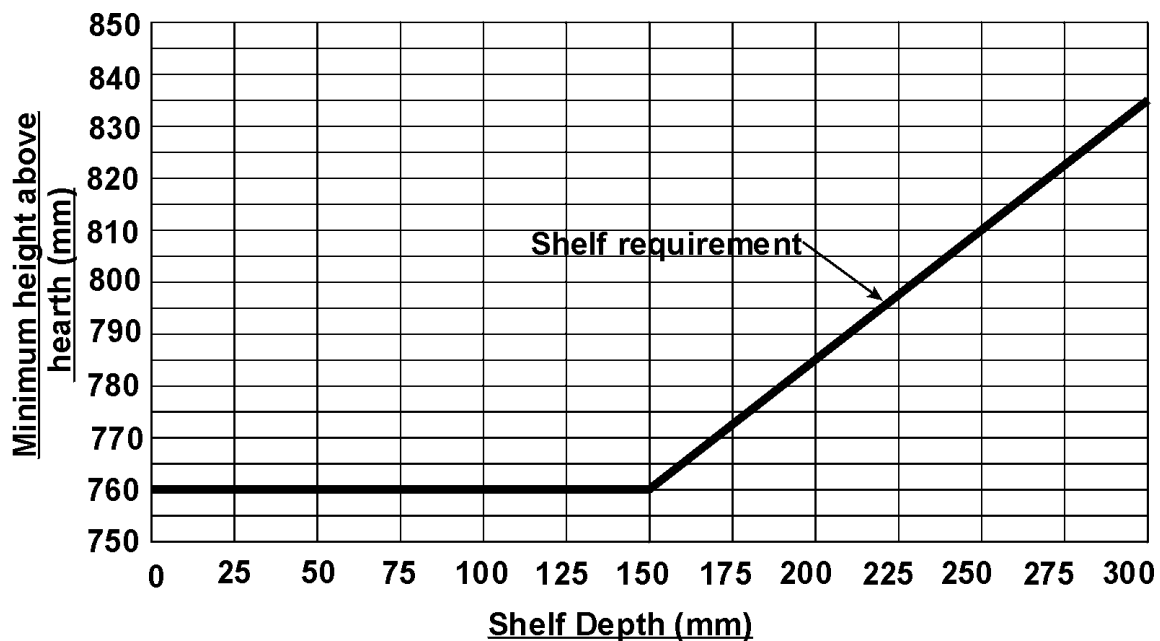

Graph 2. Combustible shelf clearances.

OWNER GUIDE

Do provide a suitable guard that complies with BS 8423 for the protection of young children, the elderly and the infirm. Such a guard is also recommended for the protection of pet animals. (Although this fire conforms to all the applicable standards, it is a heating appliance and certain parts of its surface will become hot).

Do wait three minutes before attempting to relight if the fire is switched off or the flames are extinguished for any reason. (Your fire is fitted with a safety device that will automatically shut off the gas supply to the fire if, for any reason, the flames go out).

Do get advice about the suitability of any wall covering near your fire. Soft wall coverings (e.g. embossed vinyl, etc.) which have a raised pattern are easily affected by heat. They may, therefore, scorch or become discoloured when close to a heating appliance. Please bear this in mind whenever you are considering redecorating.

Do provide a minimum side clearance as detailed in figure 1. Please bear this in mind if ever you are considering altering the room.

Don't hang clothing, towels or any other fabrics over the fire.

Don't add any extra coals above the number stated in this guide. This could cause a safety hazard.

Don't put paper or any other material on the fire.

Don't place any combustible material (rugs, carpet, plastic tiles, etc.) on the hearth.

Don't attempt to clean or service the fire until it has been switched off and allowed to cool completely.

OWNER GUIDE

APPLIANCE DIMENSIONS

108mm minimum to combustible surface projecting beyond front of appliance (10mm clearance is necessary to non-combustible surfaces)

108mm minimum mandatory clearance to combustible surface projecting beyond front of appliance and also recommended clearance to non-combustible surfaces for access

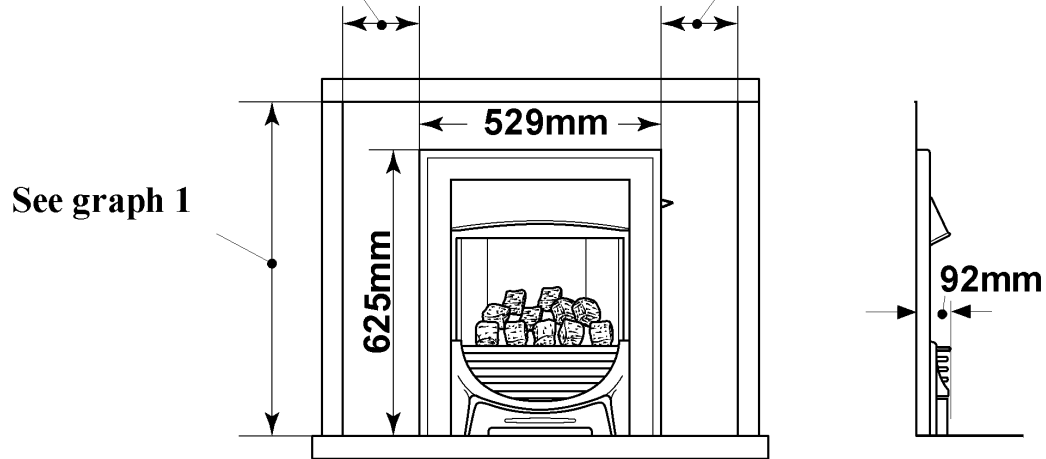

Figure 5. Appliance dimensions

OWNER GUIDE

GAS CONSUMPTION

Model 740

Has a maximum natural gas input of 6.85kW (Gross)

Has a maximum natural gas output of 4.0kW (Gross)

Has a minimum natural gas input of 2.7kW (Gross)

Has a minimum natural gas output of 1.34kW (Gross)

Model 740 when converted using kit number 0595211

Has a maximum propane gas input of 6.7kW (Gross)

Has a maximum propane gas output of 3.9kW (Gross)

Has a minimum propane gas input of 4.3kW (Gross)

Has a minimum propane gas output of 2.29kW (Gross)

OPERATING YOUR FIRE

PLEASE NOTE

When operating your fire for the first time, some vapours may be given off which may cause a slight odour and could possibly set off any smoke alarms in the immediate vicinity. These vapours are quite normal with new appliances. They are totally harmless and will disappear after a few hours use.

The Oxysafe flame sensing & flue blockage safety system.

For your safety, this appliance is fitted with a flue blockage safety device which will shut down the appliance in the event of abnormal flue conditions. ***This device is NOT a substitute for an independently mounted Carbon Monoxide detector.***

The device will also automatically shut off the gas supply to the fire if the pilot flame goes out due to lack of oxygen or for any other reason.

If this device starts to repeatedly shut off the gas, get expert advice.

This device incorporates a probe which senses that the heat from the pilot flame is correct. If this probe is cool, the device will prevent any gas flow unless the control knob is held in at the ignition position.

If, for any reason, the flames go out when the fire is hot or if the fire is turned off when hot, always ***wait at least three minutes before attempting to relight.***

OWNER GUIDE

To light the fire

The slide control is shown in figure 2.

1. Slide the control button to the bottom (ignition) position marked 

In this position, the electronic ignition system should cause a series of sparks that should light the pilot. Within four seconds of the pilot igniting, the main burner should light at its minimum setting.

If no sparks are produced to light the pilot, the battery may need replacing. Details of battery replacement are given further on in this manual.

Until you can obtain a replacement battery the fire can be lit with a taper as described later in the instructions.

2. Keep the button at the ignition position for a further ten seconds. This will prevent the flame-sensing device from shutting off the gas while its probe warms up as explained above.

3. If low heat is required, release the button. The button will automatically spring up to the low heat position shown in figure 2 (See note i below).

4. For a higher heat level slide the button upwards. The burner flames and heat output will gradually increase until the button reaches the high heat position shown in figure 2. When the button reaches the high heat position you will feel a check to its movement.

Do not slide the button above the high heat position unless you want to turn the fire off (See note i below).

Note i) If the flames go out while setting the control, repeat the full lighting procedure. If the flames repeatedly go out have the fire serviced.

ii) Please note. When first turned on the flames will appear predominantly blue. The coals will take time to warm up. Although some glow will be seen after approximately ten minutes, the full visual effect will only be apparent after a somewhat longer time.

iii) The appliance will operate to its maximum potential if the flue is primed during the first 20 – 30 minutes of operation. To do this, simply slide the control button to its highest setting. This will also burn off any carbon deposits that may have formed during previous operations.

iv) If operating the appliance for long periods it is beneficial occasionally to change the settings. This will also help to remove any carbon deposits that

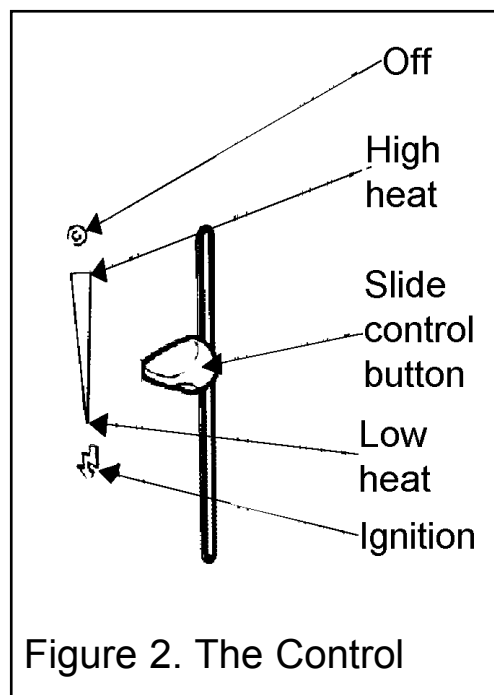

Figure 2. The Control

OWNER GUIDE

may form during operation.

To turn the fire off

Slide the button up past the high heat position to the “O” position.

Both the main burner and the pilot should go out.

While cooling, the coals may make some crackling noises. This is quite normal.

Lighting with a taper

See figure 3.

In the unlikely event of failure of the ignition spark, the pilot can be lit by a taper or long spill. Insert the taper or spill between the second and third left hand ceramic fuel effect pieces along the first row.

Operate the slide control as described above.

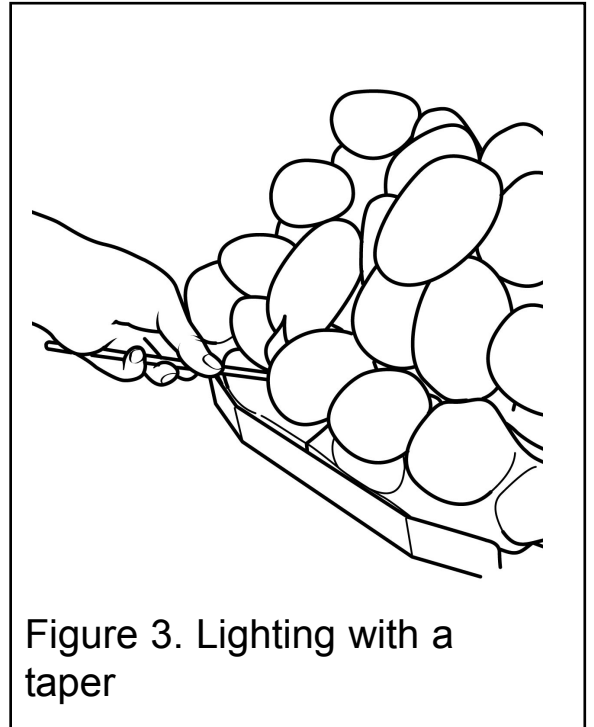

Figure 3. Lighting with a taper

OWNER GUIDE

CLEANING

To maintain the high performance and quality finish of your fire please follow these guidelines:

- Before attempting to clean the fire, please remember to turn off the fire and wait for the appliance to cool. The fire will retain heat for some time before cleaning can begin.
- If any pieces of debris are found in the firebox, have the chimney inspected before further use.

Metal Parts

- Clean the metal parts with a slightly damp cloth and then dry.
- Do not use abrasive cleaners as these will scratch the fire surface.

Coals and burner compartment walls

- **This product uses fuel effect pieces and burner compartment walls containing Refractory Ceramic Fibres (RCF), which are man-made vitreous silicate fibres. Excessive exposure to this material may cause irritation to eyes, skin and respiratory tract. Consequently, it is important to take care when handling these articles to ensure that the release of dust is kept to a minimum.**
- Light coatings of soot will usually be burnt off during the normal operation of the fire. Should any soot accumulation become excessive, the fuel effect pieces and walls should be removed from the fire for cleaning.
- Cleaning should be carried out in a well ventilated area or in the open air by gently brushing with the pieces held away from your face so that you avoid inhaling the dust.
- We do not recommend the use of a normal domestic vacuum cleaner which may blow dust back into the air.
- We suggest that you remove the coals in the reverse order to that shown in the fuel bed refitting instructions.

Burner

Remove any deposits of soot or other foreign matter from the surface of the burner with a dry soft brush. Be careful not to brush any particles into the open slots. Remove any particles from the slots with a vacuum cleaner fitted with a soft brush attachment. **Do not poke wire, etc. into the slots in the burner.**

OWNER GUIDE

FUEL BED REFITTING - CERAMIC COALS

1. Place the ceramic base coal in the burner compartment. The bottom rear face of the coal should rest on the angled ledges at the back of the burner compartment. The bottom front recess edges on the coal base should locate against the tags at the front of the ceramic support. (See figure 4).

2. Place the left-hand ceramic front coal in position in front of the base coal. The front of the ceramic coal should touch the front of the burner module (See figure 5).

3. Place the right hand ceramic front coal in position in front of the base coal. This should overlap the left-hand coal. Push the two sides together to minimise the gap. The front of the ceramic coal should touch the front of the burner module (See figure 5).

4. It is important that the front ceramics are positioned correctly and do not cover the burner ports in any way.

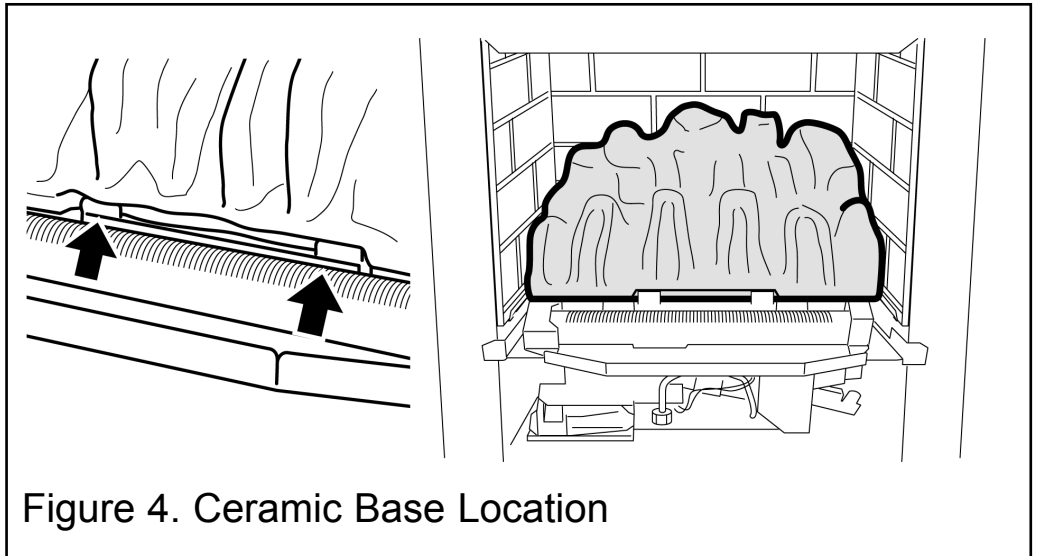

Figure 4. Ceramic Base Location

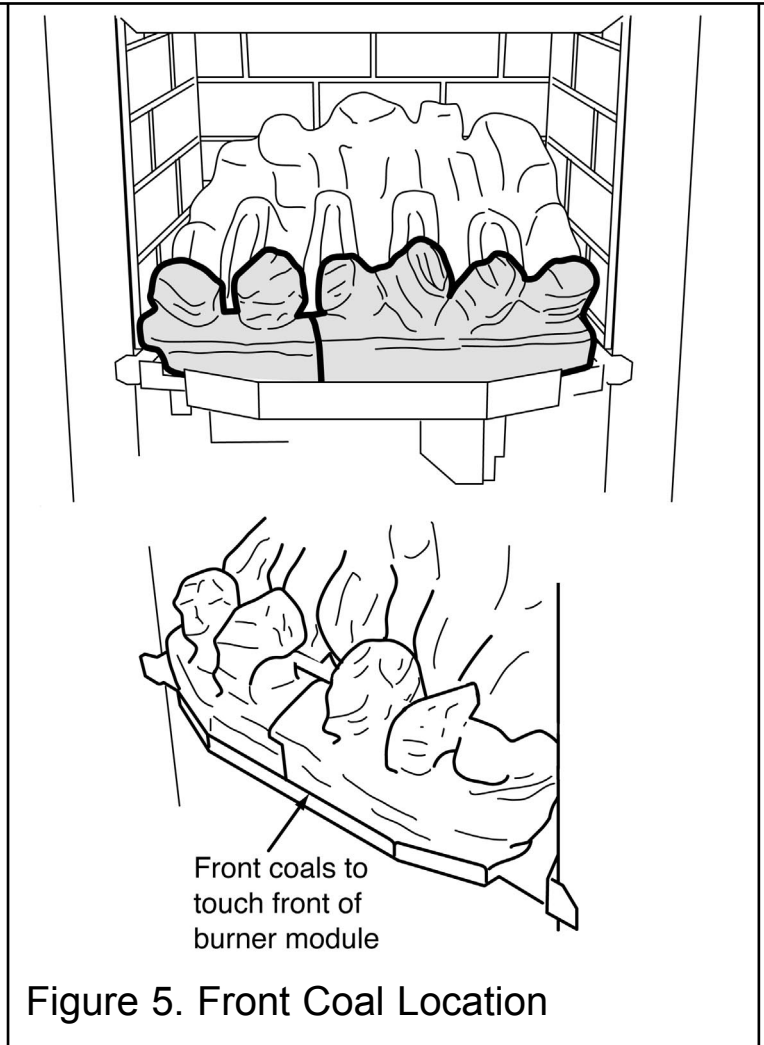

Figure 5. Front Coal Location

OWNER GUIDE

5. Install the 12 loose coals as follows. The underside of each coal is marked with a letter 'A' to 'L' and an arrow.

6. The coals should be positioned so that the arrows always point towards the back of the firebox. When located into position the stem of each arrow should be at 90° to the rear of the firebox.

7. Hold coal 'A' upright with the arrow pointing to the top. Locate coal 'A' as shown in figure 6.

8. Locate coals 'B' to 'E' so that they are firmly seated in the valleys in the coal base and front coal.

9. Hold coal 'B' upright with the arrow pointing to the top. Locate coal 'B' as shown in figure 7.

10. Hold coal 'C' upright with the arrow pointing to the top. Locate coal 'C' as shown in figure 8.

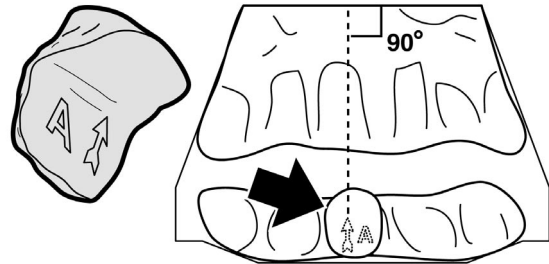

Figure 6. Front Row "Coal A"

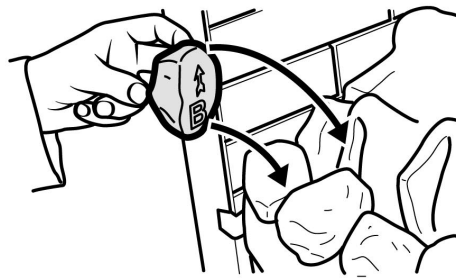

Figure 7. Second row "Coal B"

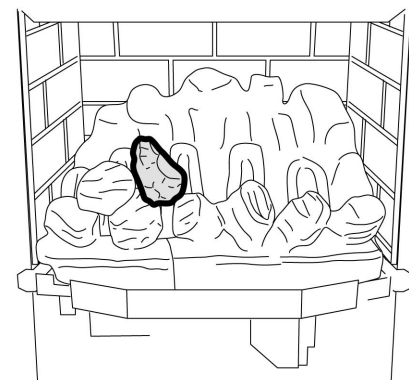
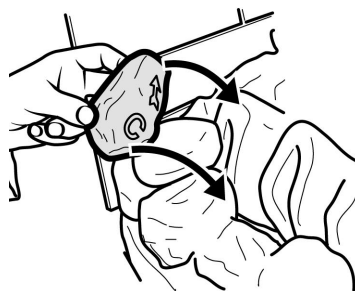

Figure 8. Second row "Coal C"

OWNER GUIDE

11. Hold coal 'D' upright with the arrow pointing to the top. Locate coal 'D' as shown in figure 9.

12. Hold coal 'E' upright with the arrow pointing to the top. Locate coal 'E' as shown in figure 10.

13. Hold coal 'F' upright with the arrow pointing to the top. Locate coal 'F' as shown in figure 11.

14. This will complete the second row of loose coals.



Figure 9. Second row "Coal D"



Figure 10. Second row "Coal E"

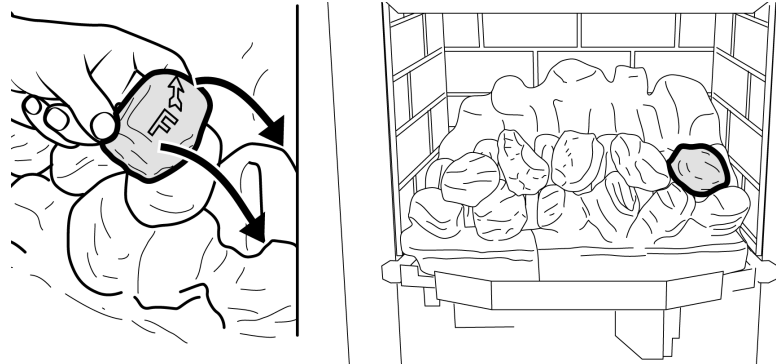

Figure 11. Second row "Coal F"

OWNER GUIDE

15. Locate coals 'G' to 'K' so that they are firmly seated in the valleys in the coal base.

16. Hold coal 'G' upright with the arrow pointing to the top. Locate coal 'G' as shown in figure 12.

17. Hold coal 'H' upright with the arrow pointing to the top. Locate coal 'H' as shown in figure 13

18. Hold coal 'I' upright with the arrow pointing to the top. Locate coal 'I' as shown in figure 14.

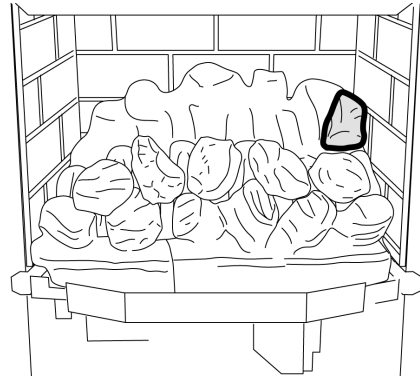
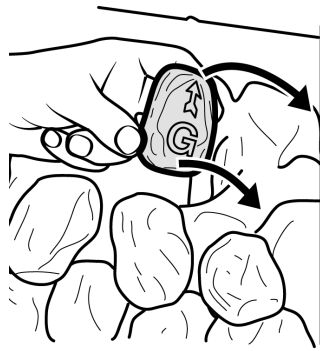

Figure 12. Second row "Coal G"

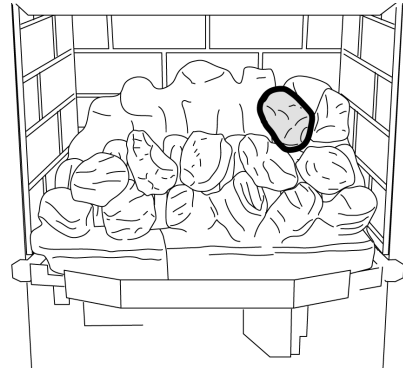

Figure 13. Second row "Coal H"

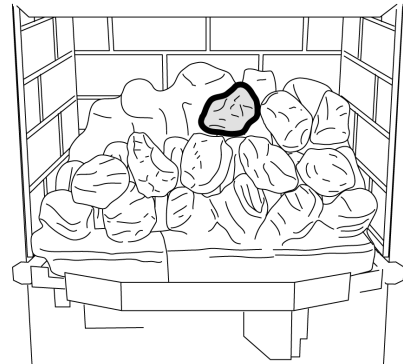
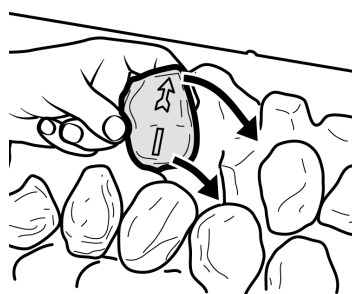

Figure 14. Second row "Coal I"

OWNER GUIDE

19. Hold coal 'J' upright with the arrow pointing to the top. Locate coal 'J' as shown in figure 15

20. Hold coal 'K' upright with the arrow pointing to the top. Locate coal 'K' as shown in figure 16

21. Hold coal 'L' upright with the arrow pointing to the top. Locate coal 'L' as shown in figure 17

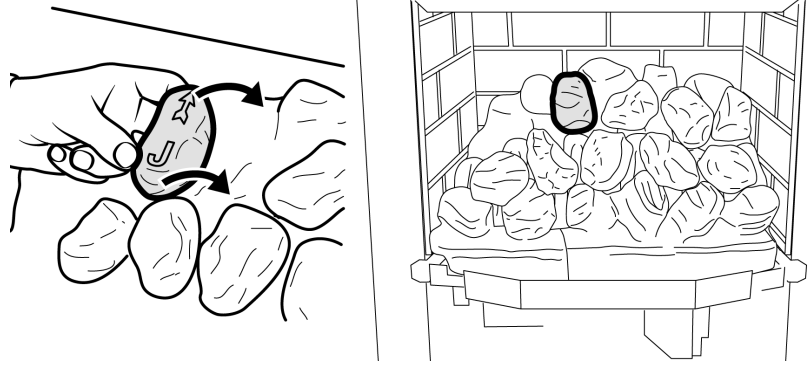

Figure 15. Second row "Coal J"

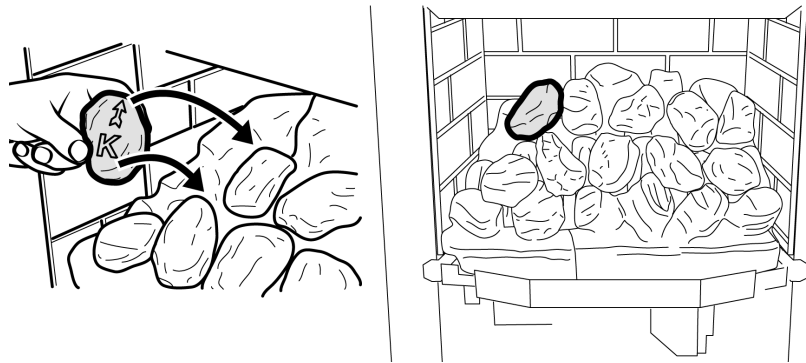

Figure 16. Second row "Coal K"

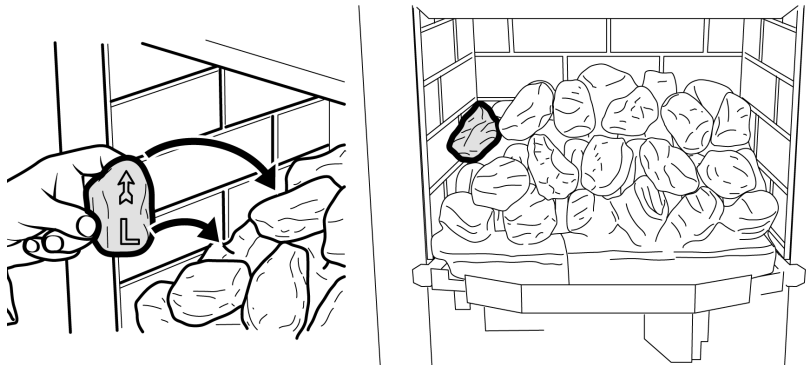

Figure 17. Second row "Coal L"

OWNER GUIDE

MAINTENANCE

Battery replacement

This appliance requires one 9V PP3 Ever Ready Silver Seal (or equivalent) battery.

To replace the battery remove the bottom front cover casting.

Fit the new battery firmly to the connections on the ignition block (See figure 18).

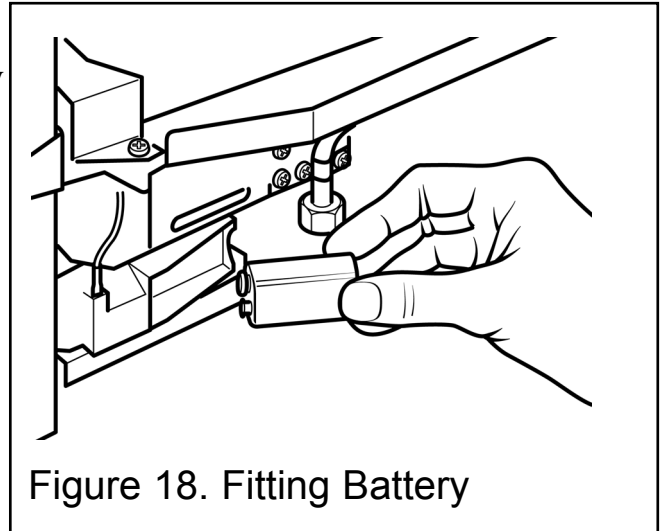

Figure 18. Fitting Battery

Regular maintenance

- In order to achieve and maintain high levels of personal safety and performance efficiency, it is essential that the opening at the back of the fire and the flue are kept clear of any form of obstruction. It is possible that deposits of mortar or soot could fall and accumulate causing the flue to be blocked or restricted and so preventing proper clearance of dangerous exhaust fumes.
- In the United Kingdom it is the law that a landlord must have any gas appliance, flue and pipework which is situated in a tenant's premises checked for safety at least every twelve months by a competent person (In the U.K, a CORGI registered installer).
- We recommend that all gas appliances and their flues, wherever situated, are checked annually.
- If you require your fire to be serviced, please contact British Gas or Scottish Gas

TELEPHONE 0845 950 0400 and please quote the following details which can be found on a 'swing' plate located below the burner behind the bottom hearth casting

a) Model and G.C. number.

b) Serial Number (To be found on a 'swing' plate located below the burner and behind the bottom front cover).

OWNER GUIDE

If you wish to replace any of the owner replaceable parts listed below, please quote the part number when ordering

Description	Part No.
Base Coal	5108040
Front Coal Set	5108553
Pack of 12 Loose Coals	3002193

When fitting replacement parts, follow the instructions contained in this guide. It is important that only approved parts are used for maximum safety.